

4M 4x IR Network Active Deterrence 3inch Mini PTZ

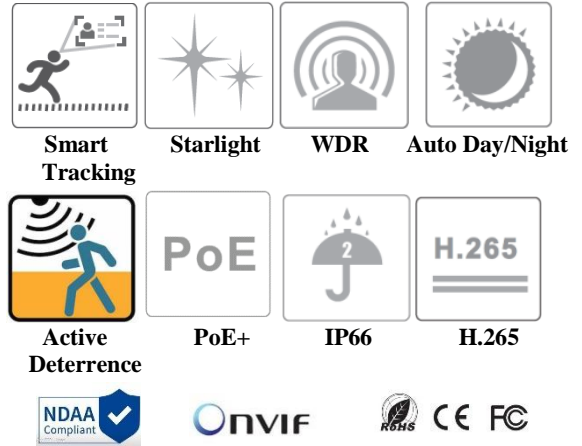

TD-8343IE3N(A/PE/04M/AR5)



System

TD-8343IE3N (A/PE/04M/AR5) the 4MP 4x Network IR mini PTZ, adopts high quality 4x optical AF lens and could output max 4MP30fps ultra HD stream, covering a medium size area. Featuring its high performance, it could meet the demand of small-sized video surveillance application. The H.265 encoder could reduce video bandwidth to 50% of H.264 without loss of image details. With high-performance AI engine, it supports multiple human/vehicle detection, classification and auto tracking and active deterrence. In a typical dim night, upon detecting of illegal intrusion, the camera will trace moving object, zoom fit in the center screen, turn off IR light, turn on strong white light, and play warning sound until the object leaves out of the perimeter area. Then the camera will return to patrol mode-- scan 360° around to find invaders, and so on. With deterrence mode, the camera captures colorful images instead of B/W, improving confidence as court evidence. While in patrol, the PTZ keeps silent and no strong white light disturbs to neighbors and community. The series of PTZ conforms to the ONVIF specifications ensuring interoperability between network video products regardless of manufacturers, and also complies with NDAA 2019. This PTZ has metal main body, water-resistant glass, IP66/IK10 class protection, which could work 7/24h in common outdoor weather.

Key Spec:

- Progressive scan BSI+NIR image sensor
- Up to 2560x1440 resolution
- Mini illumination:
 - Color: 0.01 lux @ (F1.6 AGC ON)
 - 0 Lux with IR
- 4x optical zoom, fast and accurate
- Smart 4 IR LEDs, up to 50m; 2 white LEDs, up to 30m
- Bi-directional audio, built-in Mics &Speaker
- 30m for audible warnings,7m for voice recording
- AI-based human vehicle detection &classification and tracking, perimeter precaution, crossing line, etc.
- SD/TF card chamber, Reset button, Alarm in/out
- PoE+ or DC12V power supply, easy installation
- IP66 water-proof, IK10, -40 °C~70 °C
- Onvif, API, SDK, IE/NVR/VMS/free mobile Apps

Application:

With good image quality and protection, This PTZ camera could meet the demand of small size of video surveillance product. It is suitable for school, hospital, medium residential community, small parks, swimming pool, factories, feedlot, etc.

SPECIFICATION:









Camera Module					
Image Sensor	1/2.7" progressive scan CMOS with BSI and NIR+ technology				
Mini. Illumination	Color: 0.01 Lux @ (F1.6, AGC ON); B/W: 0.002Lux @(F1.6, AGC ON); 0Lux with IR				
Image Setting	Flip, Mirror, Saturation, Brightness, Contrast, Sharpness, AGC, and AWB adjusted by client				
Shutter Speed	50Hz: 1/25s~1/25,000s, 60Hz: 1/30s~1/30,000s				
White Balance	Auto/Manual/Indoor/Outdoor				
Gain	Auto/Manual				
Day & Night	Auto/Manual				
Aperture Control	N/A				
S/N Ratio	≥52dB				
3D DNR	Auto/Manual				
AE Enhancement	BLC, HLC, WDR				
Privacy Mask	4 Programmable privacy masks				
Picture Overlay	Logo picture could be overlaid on video with 128x128pixels, 24bits JPG format				
Font Overlay	Max 15characters per line, 8 lines max, white color or red color				
Lens					
Focus Length	f=2.8-12mm lens,4x optical				
Zoom Speed	About 1.6s (Wide->tele)				
Field of View	Horizontal: 97 °to 31 °±5%; Vertical: 51 °to 18 °±5%; Diagonal: 115 °to 36 °±5% (wide-tele)				
Working Distance	Wide: 0.3m ~ INF; tele: 0.5m ~ INF				
Aperture Range	F1.6~ F2.7 (wide-tele)				
IR Cut Filter	Electrical switchable ICR				
DORI table	Lens	Detect(25px/m)	Observe(63px/m)	Recognize(125px/m)	Identify(250px/m)
	2.8mm	68m(223 f.t)	27.1m(88.9 f.t)	13.6m(44.6 f.t)	6.8m(22.3 f.t)
	12mm	206.7m(678.1 f.t)	82m(269 f.t)	41.3m (135.5 f.t)	20.7m(68f.t)
PTZ					
Pan Range	0~355 °				
Pan Speed	Configurable, from 0.1~80 %s; Preset speed: 80 %s				
Tilt Range	From -5 °to 90 °				
Tilt Speed	Configurable, from 0.1 ~ 60 %s, Preset speed: 60 %s				
Pan/Tilt Action Interval	At least 10 seconds, adjustable				
Proportional Zoom	Yes				
Preset	300				
Cruise	8 cruises, up to 16 presets for each cruises				
Trace	4 traces, record time over 3 minutes for each trace				
Power-off Memory	Support				
Action Mode	Preset/Cruise/Trace/Auto Scan/Random Scan				
3D Positioning	Support				
PTZ Position Display	Support				
Schedule Task	Preset/Cruise/Trace/Random Scan/Boundary Scanning /Dome reboot				
Supplement Light					
IR Distance	Up to 50m,4pcs of IR array into 2 groups, auto switch with zoom ratio				
Smart IR	Yes				
White Light Distance	Up to 30m, 2pcs of White LED Array				
White Light Mode	Flashing mode, torque mode, time interval adjustable				
Network					
Max Resolution	2560×1440				
Main Stream	25fps (2560×1440, 2048×1536, 1920×1080, 1280×960, 1280×720); 30fps (2560×1440, 2048×1536, 1920×1080, 1280×960, 1280×720)				
Sub Stream	25fps (704 × 576, 640 × 480, 352 × 288); 30fps (704 × 480, 640 × 480, 352 × 240)				

Third Stream	25fps (1280 × 720, 704 × 576, 640 × 480, 352 × 288); 30fps (1280 × 720, 704 × 480, 640 × 480, 352 × 240)
Video Compression	Smart H.265+/H.265/H.264+/H.264/MJPEG
H.264 Encoder	H.264/AVC codec BP/MP/HP, level 5.1
H.265 Encoder	H.265/HEVC codec MP, level 5.0
Video Bit rate	64Kbps ~ 16Mbps
Audio Compression	G.711 A/U
Audio Bit rate	64Kbps
Protocols	HTTP, HTTPS, IPv4/IPv6, 802.1x, QoS, FTP, SMTP, UPnP, SNMP,DNS, DDNS, NTP, RTSP, RTCP, RTP, TCP/IP, UDP, IGMP, ICMP,DHCP, PPPoE
User / Host	Up to 16 users, 3 levels: Administrator, Advanced User and Normal User
Security Measures	User authentication (ID and PW), Host authentication (MAC address); HTTPS encryption, IEEE802.1x port-based network access control; IP address filtering
Smart Features	
Basic Event	Motion detection, video tampering alarm, exception (network disconnected, IP address conflict, SD full, SD error)
Face Recognition	Default do not support human face detection capture, face comparison(customized per request)
Road Traffic	Vehicle detecting and tracking, etc.
Smart Detection	Tripwire, Bi-directional tripwire, Illegal intrusion detection, Region entrance detection, Region exiting detection, etc.
Smart Tracking	Smart tracking of human or vehicle, auto/manual
Active Deterrence	Flash strong white light and predefined voice upon invaders detected. Support 10+ different predefined voice clips
Two-way talk	Support two-way talk
System Integration	
Ext. Audio Interface	1-ch audio input(mic in),2.0-2.4Vp-p,1kΩ±10%;1-ch audio output(line out), line level, impedance:600 Ω;
Built-in speaker	Yes, One Speaker, 4Ω, 2.5Watt. Rotation with camera, up to 30m distance audible
Built-in MIC	1channel, rotation with camera lens direction, up to 8m distance voice recordable.
Audio device switch	Default use built-in speaker and MIC, manually switch to external
Alarm interface	1CH alarm input(Dry contact); 1CH alarm output
Alarm Linkage	Alarm actions, such as Preset, Cruise, Trace, Memory Card Video Record, Trigger Recording, Notify Surveillance Center, Upload to FTP/Memory Card, Send Email, etc.
Network Interface	1 RJ45 10M/100M Adaptive Ethernet (Support PoE+)
Storage Slot	Standalone memory card chamber, support micro SD/TF card, up to 256GB
Serial Interface	N/A
Auxiliary Video Out	N/A
Reset Button	Yes
Heat and Fan	Built-in temperature sensor, auto shut down at over-temperature; auto heat at cold start. No built-in fan.
Water Removal	Dust and Water-resistant coating
API	ONVIF, support TVT SDK and third-party management platform
Client	TVT N9000 1.4.5, TVT NVMS 2.0; and the third-party client, free iOS and Android APP
Web Browser	IE8-11, plug-in free
App Version	5.1.1 and later
General	
Languages	Czech; English, German; Hungarian; Italian; Japanese; Korean; Portuguese, Polish; Russian, Romanian, Spanish; Spanish (Mexico);Simplified Chinese; Turkish; Traditional Chinese. etc.
Power	DC12V ±20%, 2000mA ,orPoE+ (802.3.at,class 3), AVG 3.3W, MAX14.9W at day;18.9W at night(LED on+ Speaker on + PTZ working)
Working Condition	-40 °C ~ 65 °C (-40 °F ~ 149 °F) IR off, -40 °C ~ 55 °C IR on; Cold start≥- 25 °C(1Hour waiting), ≤90%RH
Storage Condition	-40 °C ~ 70°C ; ≤ 95% RH
Protection	6000V Lightning Protection, Surge Protection and Voltage Transient Protection
Shield Material	Main body: Aluminum Alloy(ADC12),Decoration: Polymer(Glass fiber and Plastic)
Dimensions	Φ 130mm x 162mmH (Φ 5.1" x 6.4")
Net Weight	Approx. 1.2Kg (2.645lb.)
Certification	IP66,IK10(include lens window), ROHS, CE, FC,UKCA, 3C

Ordering information

PTZ Camera	TD-8343IE3N(A/PE/04M/AR5)	4MP 4x Network 50m IR active deterrence 3inch PTZ, DC12V/PoE+, IP66/IK10,-40°C~65°C, including YZJ1101 mount adaptor (power adaptor is not included)
------------	---------------------------	--

Mounting

TD-YZJ1101 (default included)	TD-YZJ1101+TD-YXH0206	TD-YZJ1101+TD-YZJ0204	TD-YZJ1101+TD-YZJ0409	TD-YZJ1101+TD-YZJ0409+TD-YZJ0501	TD-YZJ1101+TD-YZJ0409+TD-YZJ0601	TD-YZJ1101+TD-YZJ0317	TD-YZJ1101+TD-YZJ0813
Indoor In-ceiling mounting	Outdoor In-ceiling mounting	Indoor/outdoor wall mounting	Indoor/outdoor Wall mounting	Indoor/outdoor Pole mounting	Indoor/outdoor Corner mounting	Wall mounting with junction box	Indoor/outdoor Pendant mounting
							

Accessories:

- Included:



TD-YZJ1101
Mounting adaptor

- Optional:



DC12V3000mA
Power adaptor



P030U05AT
PoE+ Midspan(UL/FCC/CE)



ONV-POE31004PL
PoE+ Network switch



TD-K23
PTZ Network Keyboard



TD-YXH0206
Junction box



TD-YZJ0204
Wall mounting bracket



TD-YZJ0409
Wall mounting bracket



TD-YZJ0409+TD-YZJ0501
Pole mounting bracket



TD-YZJ0409+YZJ0601
Corner mounting bracket



TD-YZJ0317
Wall mounting junction box



TD-YZJ0813
Pendant mounting bracket

Dimensions(mm/inch):

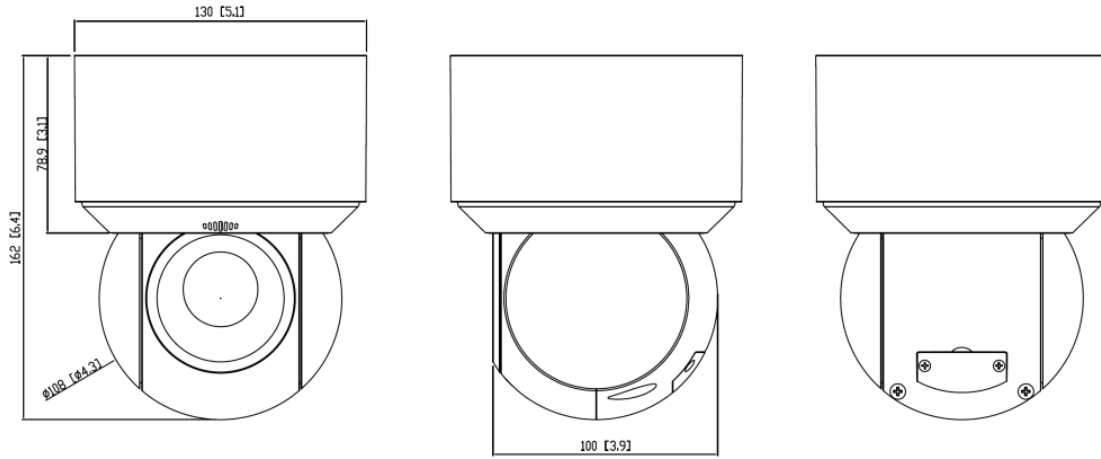

*All texts, pictures and data subject to change without notice.

Shenzhen TVT Digital TECHNOLOGY CO.,LTD

Address: 23rd Floor, Block B4, Building No.9,Shenzhen Bay, Eco-Technology Park, Nanshan District, Shenzhen, Guangdong

Province, P.R.China

Tel: +86-755-36995888 Web site: <http://en.tvt.net.cn>

Fax: +86-755-33104777 E-mail: overseas@tvt.net.cn